

- Dramatic proportions highlight classic Italian style.
- The draft tower is a marketing tool, not just a bar fixture.
- Ceramic color complements the bar top.
- All stainless steel contact with the beer for the ultimate in draft purity.



Brass
CT900-4BRKR





Chrome
CT900-4CHKR

Features

Faucet knobs not included.

 Certified by the National Sanitation Foundation.

 Stainless Steel beer contact for the pure taste of fresh draft beer.

 The integrated Kool-Rite module provides optimum cooling at the point of dispense. Modular construction makes the installation process as simple as PLUG "N" POUR.

Specifications

Micro Matic reserves the right to change specifications without notice.

Part No.	Faucets	Finish	Dispense System	Shipping Weight	Box Dimensions
<input type="checkbox"/> CT900-4CHKR*	4	Chrome	Kool-Rite (Glycol)	12 kg 27 lbs	1016mm L x 622mm W x 533mm H 40"L x 24 1/2"W x 21"H
<input type="checkbox"/> CT900-4BRKR*	4	Brass	Kool-Rite (Glycol)	12 kg 27 lbs	1016mm L x 622mm W x 533mm H 40"L x 24 1/2"W x 21"H

 Certified

Dimensions

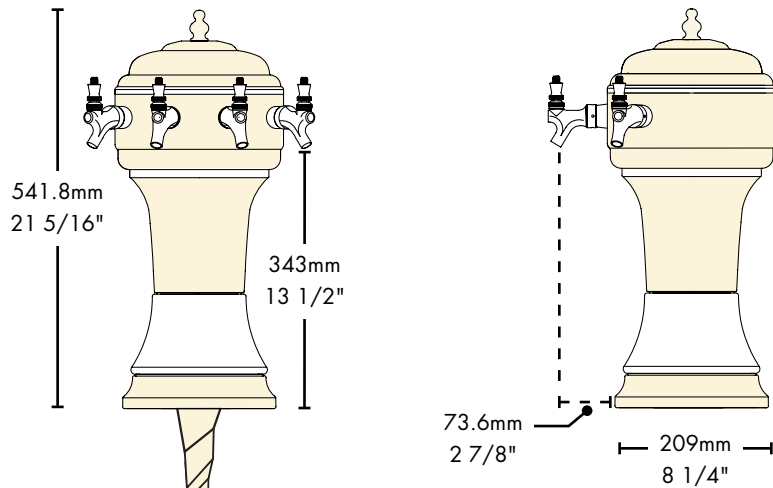

BEER:

6.4mm (1/4") O.D. Stainless Steel
with 7.94mm - 9.52mm (5/16" - 3/8") Barb Fittings

GLYCOL:

9.52mm (3/8") O.D. Copper
with 9.52mm (3/8") Barb Fittings

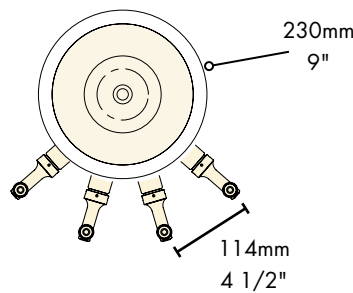
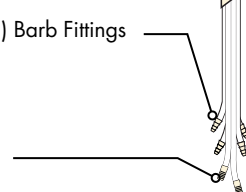

Mounting Guide

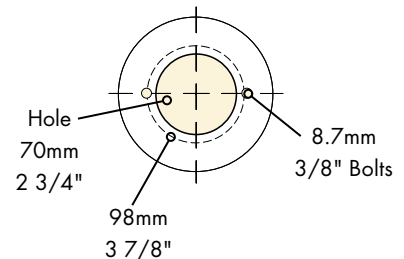

Copyright ©2007 Micro Matic USA, Inc. All Rights Reserved. 00228D0507 12-07



www.micromatic.com

Toll Free: 1-(866) 327-4159

West	Central	Southeast	Northeast
19791 Bahama Street Northridge, CA 91324 Tel. (818) 701-9765 Fax. (818) 701-9844	10726 North Second Street Machesney Park, IL 61115 Tel. (815) 968-7557 Fax. (815) 968-0363	16121 Flight Path Drive Brooksville, FL 34604 Tel. (352) 799-6331 Fax. (352) 796-2429	4601 Saucon Creek Road Center Valley, PA 18034 Tel. (610) 625-4464 Fax. (610) 625-4466