

Suction and line filters

Line filters – 220 psi maximum pressure rated

Filter bodies

- Polypropylene or fiberglass reinforced nylon
- Polypropylene back nuts
- EPDM gaskets, Viton® available upon request
- 304 Stainless Steel internal components
- External fasteners are Brass

Filters

- Polypropylene w/304 Stainless Steel mesh

	Dimensions	Screen Mesh	Effective Area (Sq. In.)	Part No.	
	F				
	1 1/4" F NPT		32	18	Y8121008
			50	16.4	Y8121009
			80	15	Y8121010
			100	16	Y8121011
	1 1/2" F NPT		32	18	Y8121012
			50	16.4	Y8121013
			80	15	Y8121014
			100	16	Y8121015

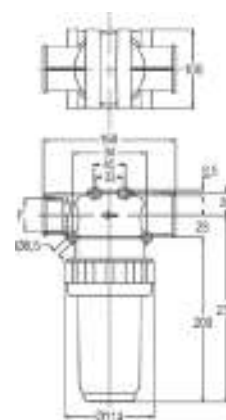

All dimensions in mm (except as noted)

Replacement parts

	Part	Part No.
	32 Mesh Screen - White	YC00100032
	50 Mesh Screen - Blue	YC00100033
	80 Mesh Screen - Gray	YC00100034
	100 Mesh Screen - Red	YC00100035
Gasket	YG00001046	

Suction and line filters

Line filters – 220 psi maximum pressure rated

Filter bodies

- Polypropylene or fiberglass reinforced nylon
- Polypropylene back nuts
- EPDM gaskets, Viton® available upon request
- 304 Stainless Steel internal components
- External fasteners are Brass

Filters

- Polypropylene w/304 Stainless Steel mesh

	Dimensions	Screen Mesh	Effective Area (Sq. In.)	Part No.	
	F				
	1/2" F NPT		32	4	Y8105012
			50	3.7	Y8105013
			80	3.4	Y8105014
			100	3.6	Y8105015
	3/4" F NPT		32	4	Y8105016
			50	3.7	Y8105017
			80	3.4	Y8105018
			100	3.6	Y8105019

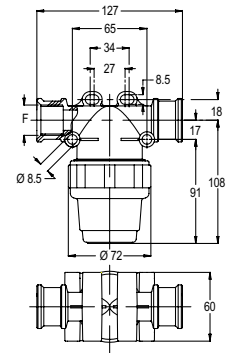

Replacement parts

	Part	Part No.
	32 Mesh Screen - White	YC00100000
	50 Mesh Screen - Blue	YC00100001
	80 Mesh Screen - Gray	YC00100002
	100 Mesh Screen - Red	YC00100003
Gasket	YG00001024	

	Dimensions	Screen Mesh	Effective Area (Sq. In.)	Part No.	
	F				
	1" F NPT		32	5.9	Y8105020
			50	5.4	Y8105021
			80	5	Y8105022
			100	5.3	Y8105023

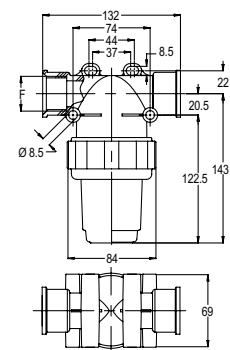

Replacement parts

	Part	Part No.
	32 Mesh Screen - White	YC00100004
	50 Mesh Screen - Blue	YC00100005
	80 Mesh Screen - Gray	YC00100006
	100 Mesh Screen - Red	YC00100007
Gasket	YG00001024	

All dimensions in mm (except as noted)

Suction and line filters

Line filters, self-cleaning – 220 psi maximum pressure rated

Filter bodies

- Polypropylene or fiberglass reinforced nylon
- Polypropylene back nuts
- EPDM gaskets, Viton® available upon request
- 304 Stainless Steel internal components
- External fasteners are Brass

Filters

- Polypropylene w/304 Stainless Steel mesh

	Dimensions	Screen Mesh	Effective Area (Sq. In.)	Part No.
	F			Female Threads
	1 1/4" F NPT	32	4	Y8122008
		50	3.7	Y8122009
		80	3.4	Y8122010
		100	3.6	Y8122011
	1 1/2" F NPT	32	4	Y8122012
		50	3.7	Y8122013
		80	3.4	Y8122014
		100	3.6	Y8122015

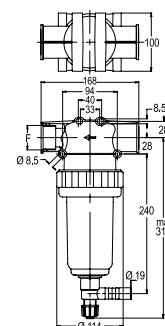

All dimensions in mm (except as noted)

Replacement parts

	Part	Part No.
	32 Mesh Screen - White	YC00100032
	50 Mesh Screen - Blue	YC00100033
	80 Mesh Screen - Gray	YC00100034
	100 Mesh Screen - Red	YC00100035
	Gasket	YG00001046

Suction and line filters

Line filters, self-cleaning with 4 mounting holes – 220 psi maximum pressure rated

Filter bodies

- Polypropylene or fiberglass reinforced nylon
- Polypropylene back nuts
- EPDM gaskets, Viton® available upon request
- 304 Stainless Steel internal components
- External fasteners are Brass

Filters

- Polypropylene w/304 Stainless Steel mesh

	Dimensions	Screen Mesh	Effective Area (Sq. In.)	Part No.	
	F				
	1" M NPT		32	5.9	Y8106004
			50	5.4	Y8106005
			80	5	Y8106006
		100	5.3	Y8106007	

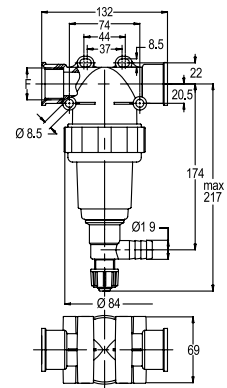

All dimensions in mm (except as noted)

Replacement parts

	Part	Part No.
	32 Mesh Screen - White	YC00100004
	50 Mesh Screen - Blue	YC00100005
	80 Mesh Screen - Gray	YC00100006
	100 Mesh Screen - Red	YC00100007
Gasket	YG00001024	

Suction and line filters

Line filters, self-cleaning – 220 psi maximum pressure rated

Filter bodies

- Polypropylene or fiberglass reinforced nylon
- Polypropylene back nuts
- EPDM gaskets, Viton® available upon request
- 304 Stainless Steel internal components
- External fasteners are Brass
- Ask about NPT threads

Filters

- Polypropylene w/304 Stainless Steel mesh

	Dimensions	Screen Mesh	Effective Area (Sq. In.)	Part No.
	F			
	1/2" M BSP	32	5.9	Y8118000
		50	5.4	Y8118001
		80	5	Y8118002
		100	5.3	Y8118003
	3/4" M BSP	32	5.9	Y8118004
		50	5.4	Y8118005
		80	5	Y8118006
		100	5.3	Y8118007
	1" M BSP	32	5.9	Y8118008
		50	5.4	Y8118009
		80	5	Y8118010
		100	5.3	Y8118011

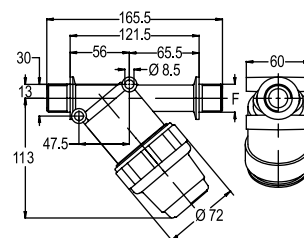

All dimensions in mm (except as noted)

Replacement parts

	Part	Part No.
	32 Mesh Screen - White	YC00100004
	50 Mesh Screen - Blue	YC00100005
	80 Mesh Screen - Gray	YC00100006
	100 Mesh Screen - Red	YC00100007
	Gasket	YG00001024

Suction and line filters



High flow rate line filters – 220 psi rated

Filter bodies

- Polypropylene or fiberglass reinforced nylon
- Polypropylene back nuts
- EPDM gaskets, Viton® available upon request
- 304 Stainless Steel internal components
- External fasteners are Brass
- Ask about NPT threads

Filters

- Polypropylene w/304 Stainless Steel mesh

	Dimensions	Max. Flow Rate (gpm)	Part No.
	F		
 Up to 68 gpm	1 1/2" M BSP	68	Y8118014
 Up to 160 gpm	2" M BSP	80	Y8118013
 Up to 210 gpm	3" M BSP	211	Y8118012

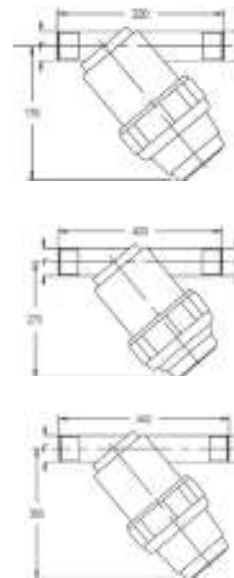

All dimensions in mm (except as noted)

Replacement parts

	Line Filter Part No.	Includes	Part No.
		Y8118014	120 Mesh Screen
Y8118013		120 Mesh Screen	YR00201059
		Gasket	YG00000025
Y8118012		120 Mesh Screen	YR00201060
		Gasket	YG00000026

Suction and line filters



Floating filters

- Shock-resistant plastic floating filter
- Sized swivel fittings assure proper flotation when hose is twisted and under load

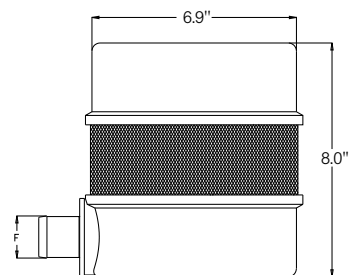
	Part	Dimensions (inches)		Part No.
		F		
	Floating filter	—		Y8062003
	Swivel fitting	1.30	YR00000020	
		1.38	YR00000021	
1.57		YR00000022		
	1.97	YR00000023		



Suction filters

	Part	Dimensions (inches)			Part No.
		F	A	B	
Suction filter for detergents (with counterweight)		0.31 (no valve)	0.87	1.57	Y8064000
	Suction filter	0.75	1.65	2.56	Y8064002
		0.98	1.65	2.56	Y8064003

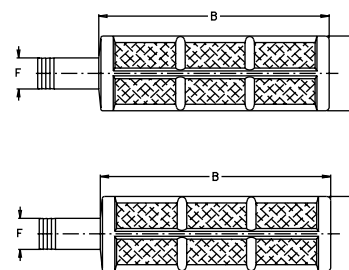

Suction and line filters



Brass line filters, 720 psi rated, 18.5 gpm maximum flow rate

Filter bodies

- Brass
- EPDM gaskets, Viton® available upon request
- 304 Stainless Steel internal components
- Polypropylene back nuts
- Ask about NPT threads

Filters

- Polypropylene w/304 Stainless Steel mesh

	Dimensions		Screen Mesh	Part No.
	F	A		
	1/2" F BSP	2.83"	30	Y8137009
			40	Y8137008
			70	Y8137010
	1/2" F BSP	3.39"	30	Y8137011
			40	Y8137004
			70	Y8137012

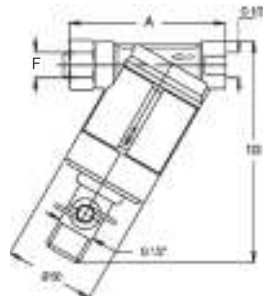
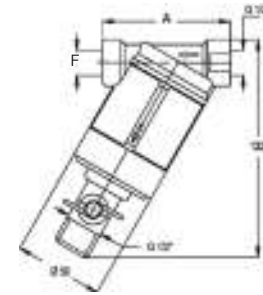

All dimensions in mm
(except as noted)

Replacement parts

	Part	Part No.
	32 Mesh Screen - White	YC00100051
	50 Mesh Screen - Blue	YC00100042
	80 Mesh Screen - Gray	YC00100052

Suction and line filters



Brass line filters, 720 psi rated, 29–40 gpm maximum flow rate

Filter bodies

- Brass
- EPDM gaskets, Viton® available upon request
- 304 Stainless Steel internal components
- Polypropylene back nuts
- Ask about NPT threads

Filters

- Polypropylene w/304 Stainless Steel mesh

	Dimensions	Screen Mesh	Flow Rate (gpm)	Part No.
	F			
	3/4" F BSP	30	40	Y8137006
		40	40	Y8137007
	1/2" F BSP	30	40	Y8137013
		40	40	Y8137014
	1/2" M BSP	40	29	Y8137005

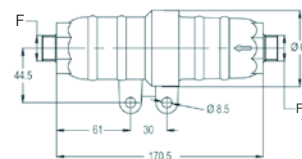
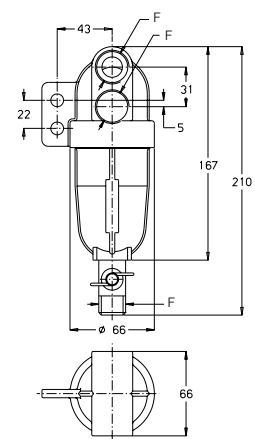

All dimensions in mm (except as noted)

Replacement parts

	Part	Part No.
	30 Mesh Screen	YC001000043
	40 Mesh Screen	YC001000044
	40 Mesh Screen for Torpedo Filter	YC001000041